

# PIPE SEALS

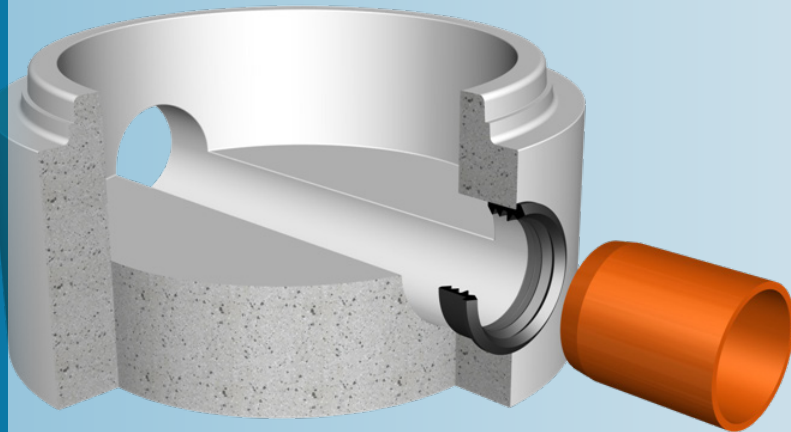

Flexible connection system for pipes to manholes and laterals to pipelines.



## SEAL DESIGN AND FUNCTION

This Pipe Seal is a rubber seal for flexible connection of pipes to manholes and laterals to pipelines. It can be used with both prefabricated and core drilled holes.

The tripple lip design allows ease of jointing and provides excellent resistance to transvers shear load whilst allowing a high level of angular deflection in the joint.

The wide range of sizes available ensure the water-tight connection of almost any pipe diameter and material.

## SEAL PERFORMANCE

The seal meets the requirement of all relevant current European standards. Joint performance is dependent on dimensional accuracy and surface finish of pipe and hole.

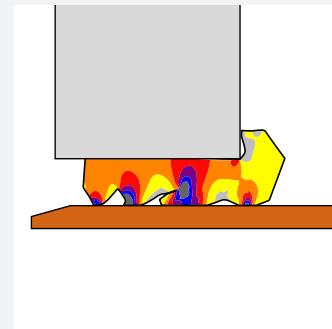

## MATERIAL

Synthetic rubber SBR or EPDM

Hardness 40±5 IRHD

Approved in accordance with EN 681-1

Protected against ozone

Available in oil resistant material

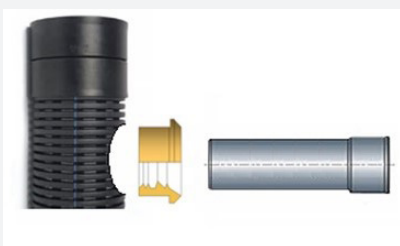

## JOINT ASSEMBLY

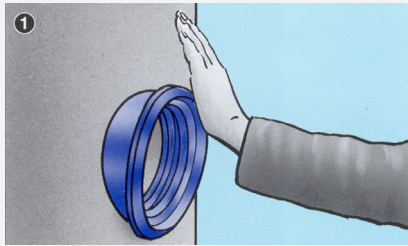

Press the seal into the hole.  
Do not use lubricant.

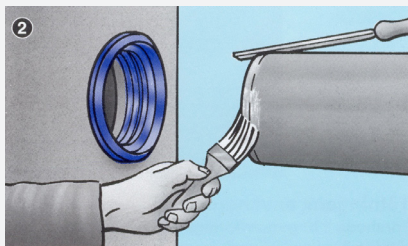

Chamfer the edge of the connecting pipe and lubricate it with lub.

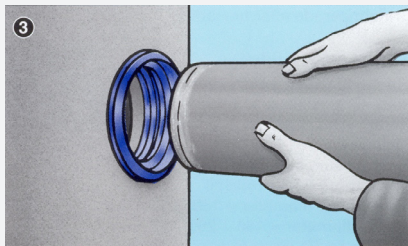

Centre the end of the pipe and push it into the seal, so that the pipe end is flush with the inner wall.

## SEAL MARKING AND BOX LABELS

Each seal is marked with outside diameter and profile thickness, plus the recommended pipe and hole diameter and period of manufacture. The box is labelled with corresponding data.

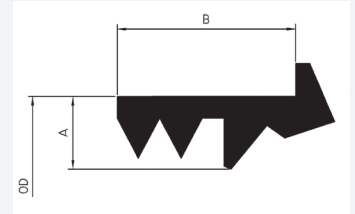

## EXAMPLES OF SIZES (MM)

A - MM	B - MM	Joint gap
16.0	38.0	10.5±1.3
20.0 *	50.0	13.0±1.8
23.0	51.0	15.0±1.9
26.6	49.2	17.3±2.0
32.0	49.5	20.8±2.4

\* For EN 1401 PVC Pipe DN 110mm the profile thickness is 21.5 mm and the joint gap is 14.0 ± 1.8mm.

Please contact our technical advice and joint design recommendations to meet your performance requirements.

Pipe connections shall always be laid in accordance with applicable standards and regulations.